

Moses Leads the Exodus—Mini Books and Pictures

Directions:

1. Read the story of Moses' leading the Exodus in Exodus 12 to 14.
2. Print the pages of your choice. Pages 2 to 5 are mini books with 8 pages. Pages 6 to the end are full-sized pictures suitable for coloring or for telling a story on a classroom wall.
3. Folding instructions: For the 8 page booklet, start by folding the page in half the long way first. Use the booklets and pictures to tell the story and then as a coloring project for the last few minutes of class. At the end of class, send the students home with a story to tell their parents and friends.

More printable Bible projects are available online at www.GospelHall.org

This document is the creative work of Shad Sluiter and retains all copyrights. Permission is granted to print, copy and distribute this document freely for the purpose of teaching the Bible without making changes and without charging any fees. Artwork was purchased from iClipart.

How to fold 8 page booklet

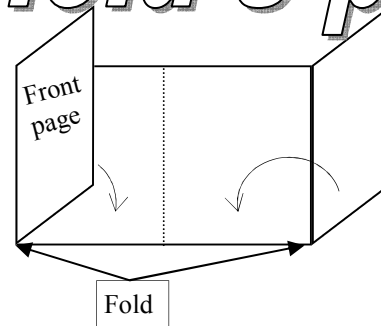
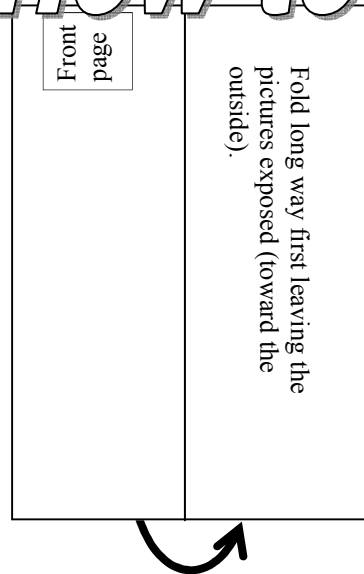

Fold first and last page to meet in the center.

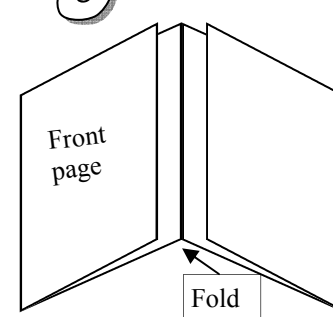

Fold the center and bend backwards.

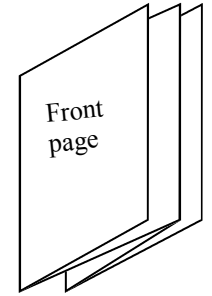

The final booklet is an accordion-style book.



Moses Leads the Exodus—

Part 1

Mini Book

By

What is he going to do with that rod? Does he think he can fight an army with sticks?

Is it because there are no graves in Egypt that you have taken us away to die in the wilderness?



Moses. Why do you cry to me? Tell the people of Israel to go forward. Lift up your staff, and stretch out your hand over the sea and divide it.



And I will harden the hearts of the Egyptians so that they shall go in after them, and I will get glory over Pharaoh and all his host.



Moses! What are we going to do? We are trapped here by the Red Sea.

Stand still and see the salvation of the Lord.



What is that? It looks like the army from Egypt is following us! We are going to be attacked!

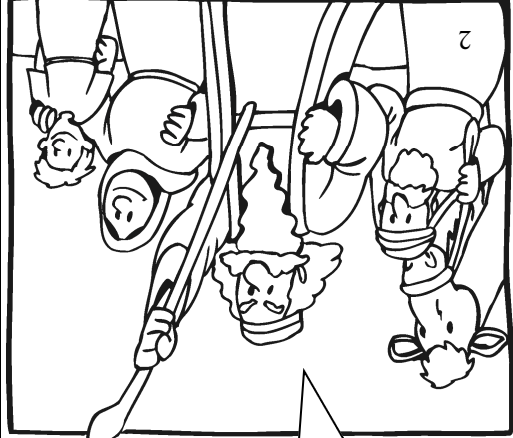

God has given us freedom through the Passover Lamb. Now let's get going to the Promised Land.



The people of Israel were slaves in Egypt, but God was about to take them out and give them freedom.

Moses Leads the Exodus—

Part 2
Mini Book
By

Look, there is dry ground beneath the waters.

Fear not, stand firm, and see the salvation of the LORD, which he will work for you today. For the Egyptians whom you see today, you shall never see again.

1

This is amazing! The waters form walls on the left and right. The wind is holding them up.

Wait until you see what God does to the Egyptian army.

2

The Lord is fighting for Israel. We have to run!

It's too late. The water is falling upon us.

3

Moses, stretch out your hand over the sea, that the water may come back upon the Egyptians.

We are saved. The Egyptians couldn't pass through the Red Sea!

4

Now the Lord will lead us through the desert to the Promised Land. See that cloud? That is God telling us the way we should go.

5

Now it's time to sing! We haven't had a reason to celebrate for 400 years, but now God has rescued us forever.

6

It looks like the Egyptians are all dead and the way is closed as if it had never been opened.

7

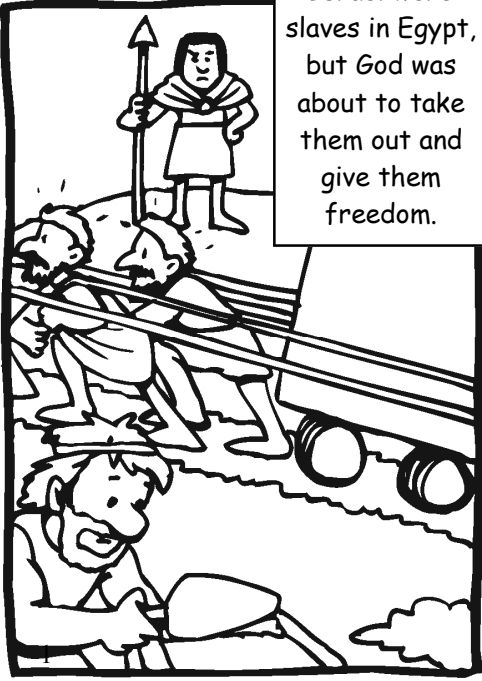

The people of Israel were slaves in Egypt, but God was about to take them out and give them freedom.



2

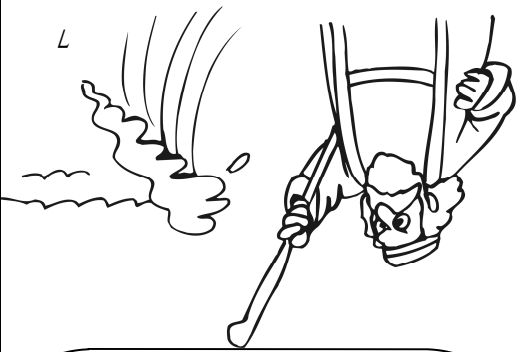

7

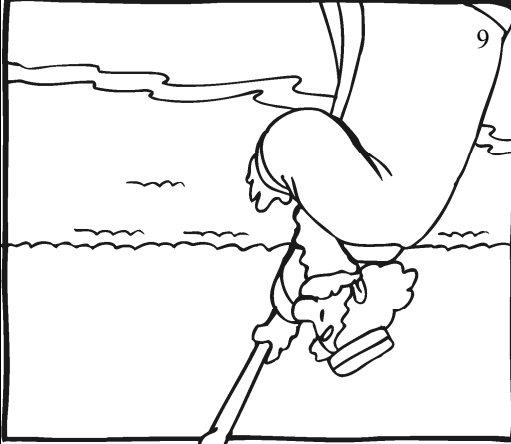

9

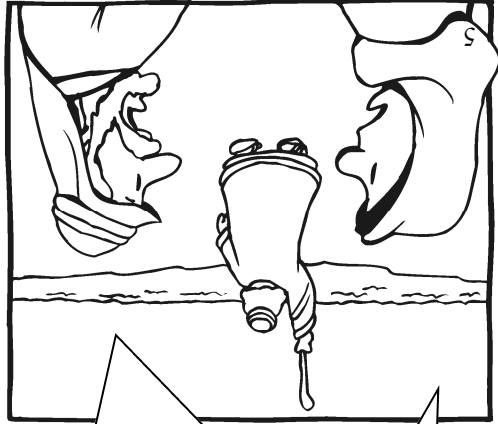

5

Moses Leads — the Exodus —

Part 1
Mini Book
By

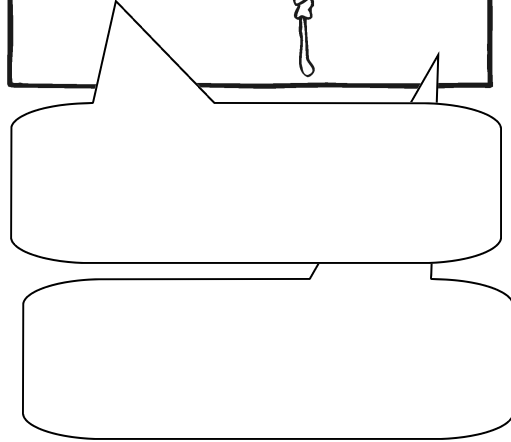
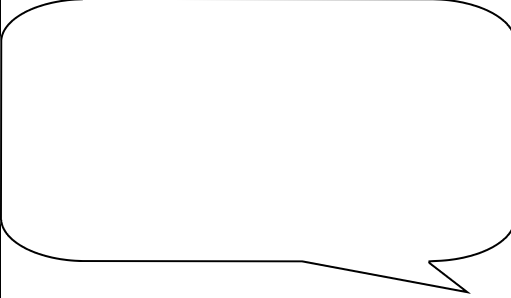
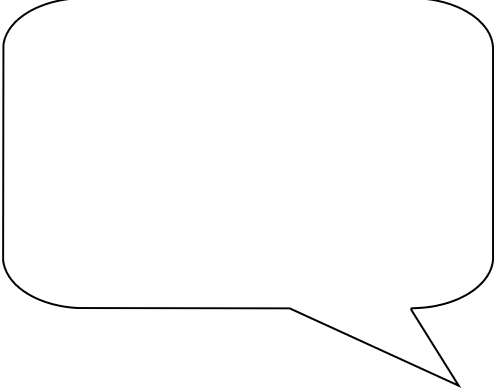

Moses Leads the Exodus—

Part 2

Mini Book

By

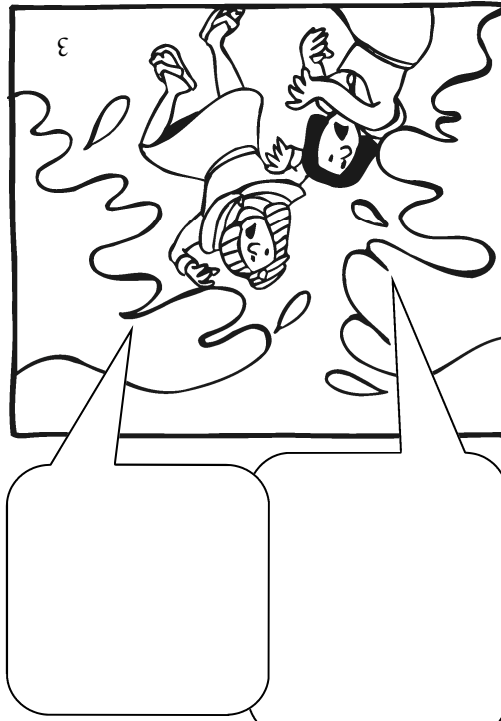
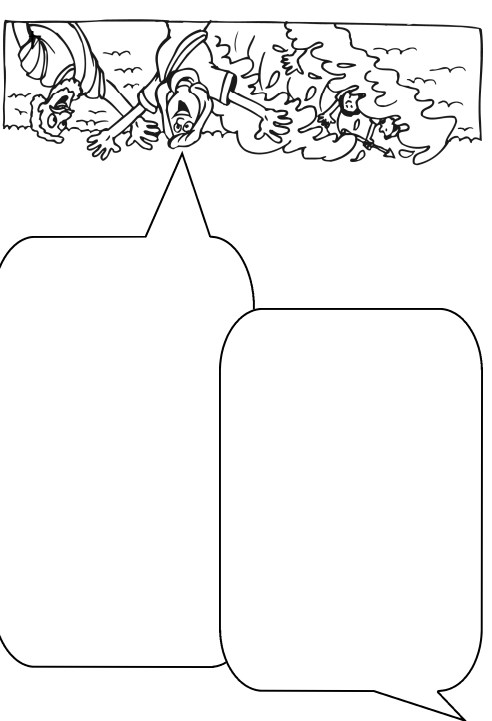

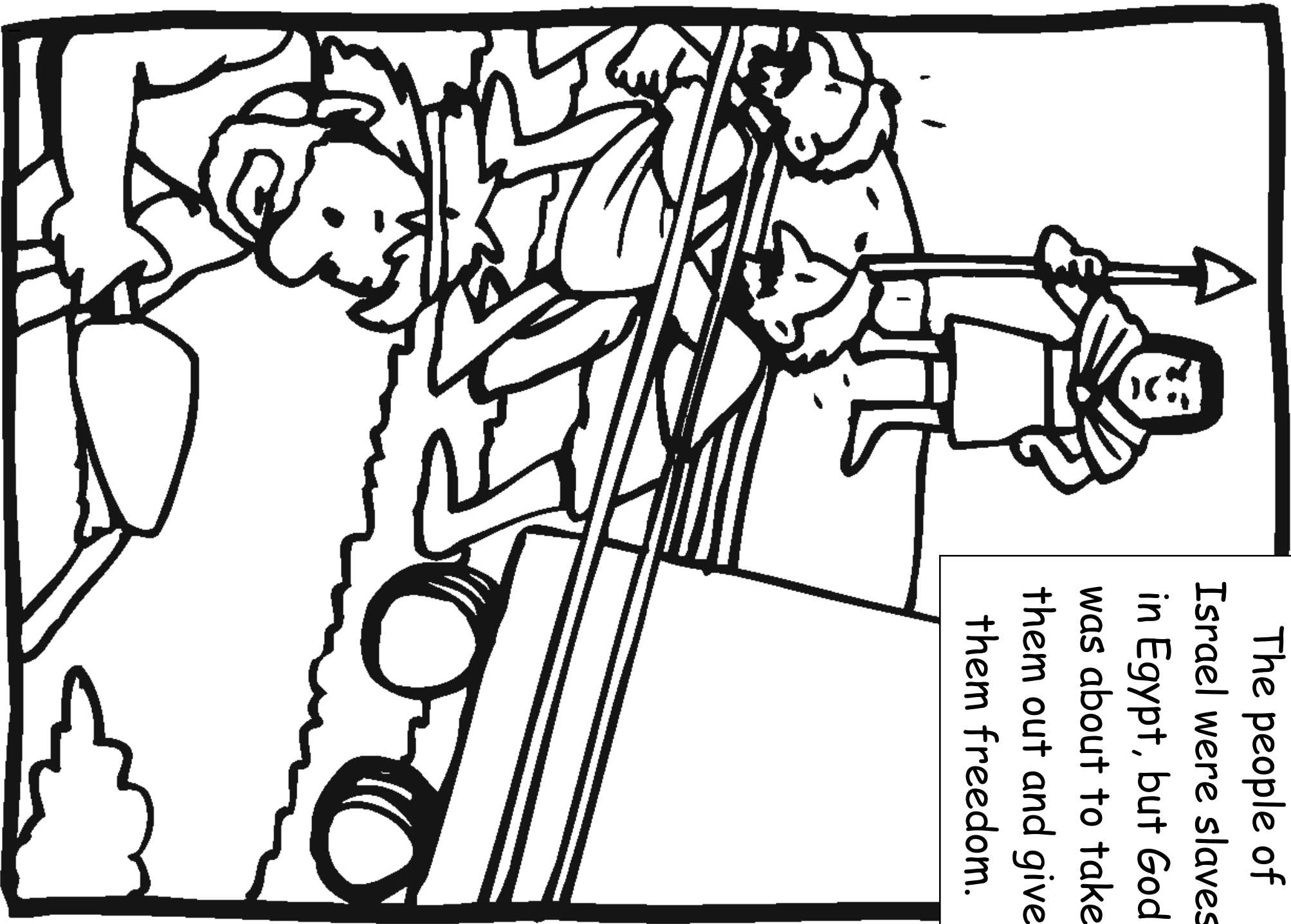

The people of Israel were slaves in Egypt, but God was about to take them out and give them freedom.

God has given us freedom through the Passover Lamb. Now let's get going to the Promised Land.



What is that? It looks like the
army from Egypt is following us!
We are going to be attacked!



Moses! What are we going to do? We are trapped here by the Red Sea.

Stand still and see the salvation of the Lord.



What is he going to do with that rod? Does he think he can fight an army with sticks?

Is it because there are no graves in Egypt that you have taken us away to die in the wilderness?





Moses. Why do you cry to me?
Tell the people of Israel to go
forward. Lift up your staff,
and stretch out your hand over
the sea and divide it.



And I will harden the hearts of the Egyptians so that they shall go in after them, and I will get glory over Pharaoh and all his host.

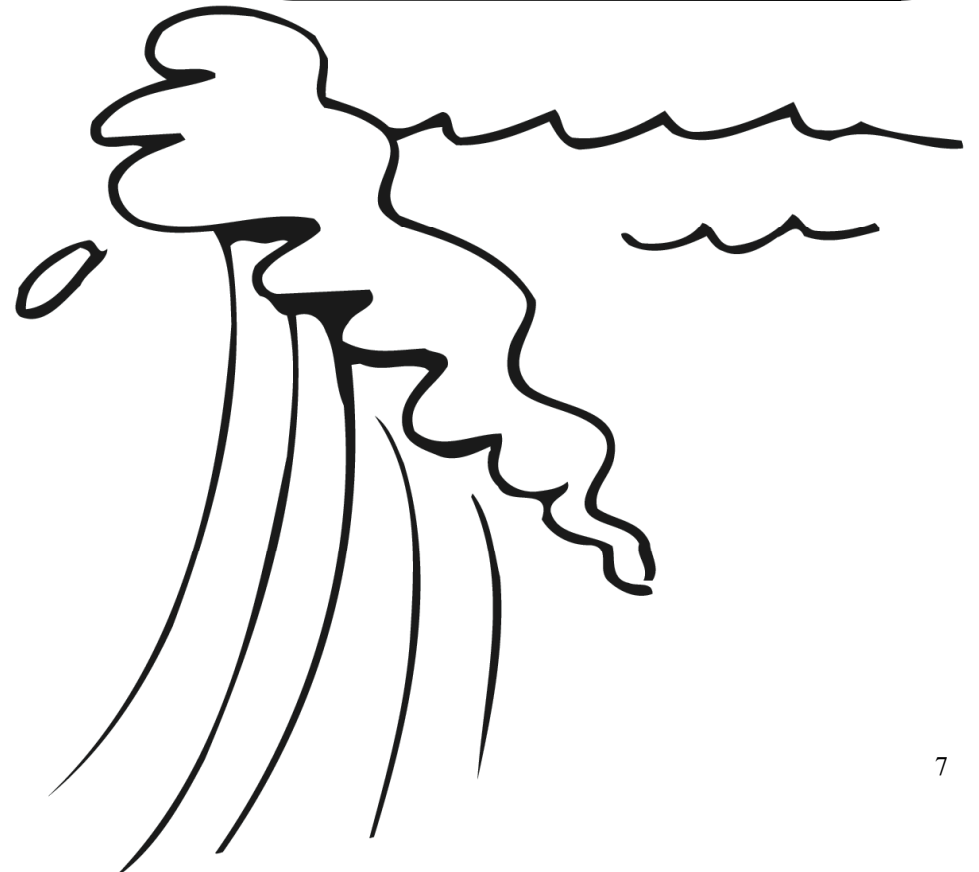

Fear not, stand firm, and see the salvation of the LORD, which he will work for you today. For the Egyptians whom you see today, you shall never see again.

Look, there is dry ground beneath the waters.



This is amazing! The waters form walls on the left and right. The wind is holding them up.

Wait until you see what God does to the Egyptian army.



The Lord is fighting for Israel. We have to run!

It's too late. The water is falling upon us.



Moses, stretch out your hand over the sea, that the water may come back upon the Egyptians.

We are saved. The Egyptians couldn't pass through the Red Sea!



It looks like the Egyptians are all dead and the way is closed as if it had never been opened.



Now it's time to sing! We haven't had a reason to celebrate for 400 years, but now God has rescued us forever.



Now the Lord will lead us through the desert to the Promised Land. See that cloud? That is God telling us the way we should go.

